

"M/V SAVA HILL"

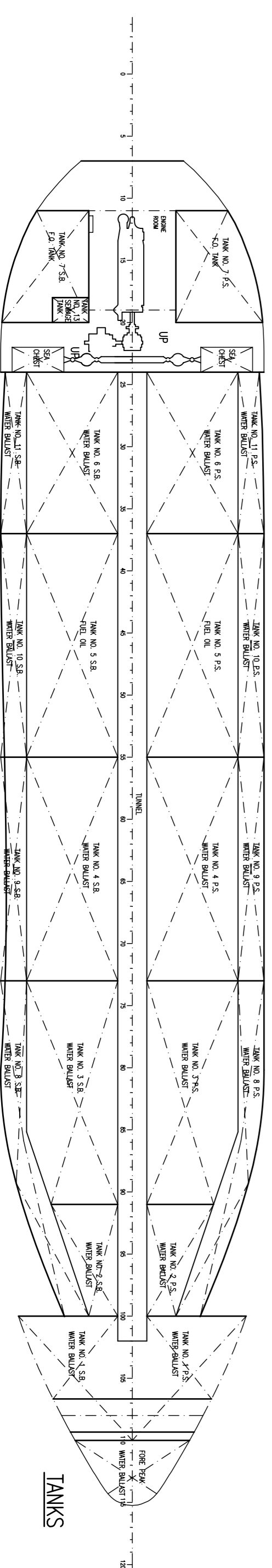
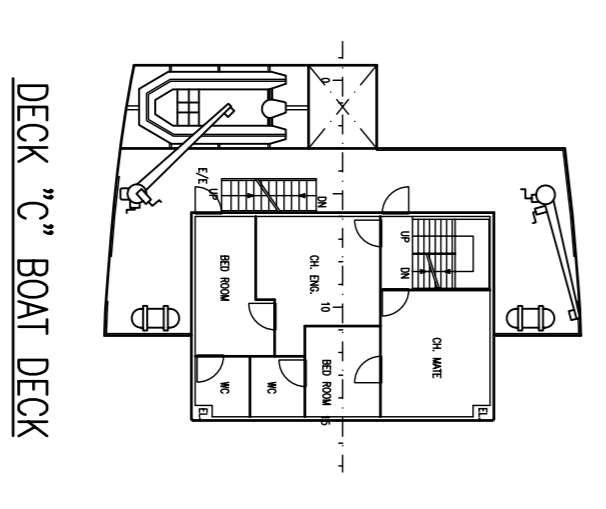
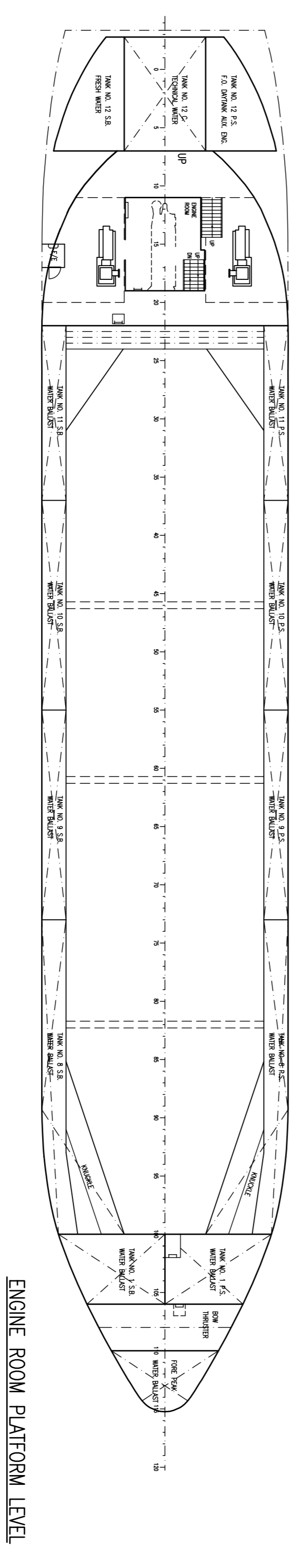
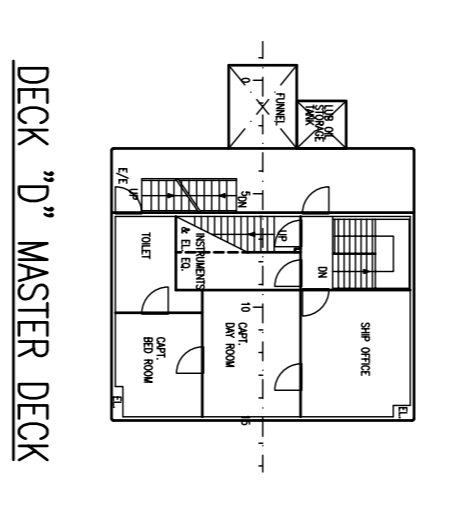
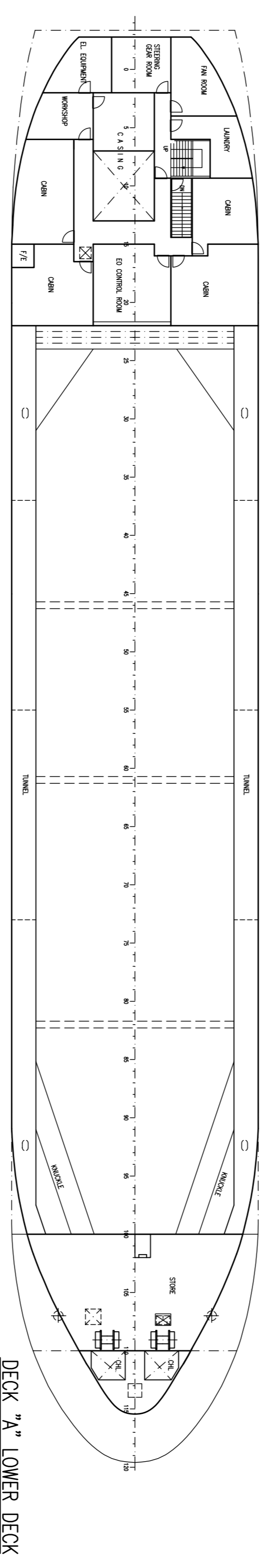
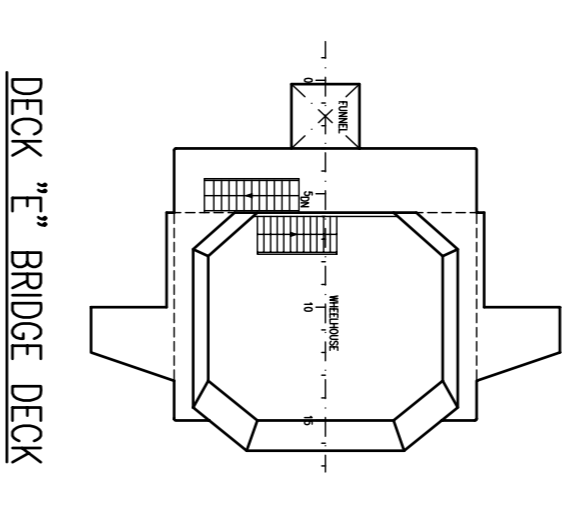
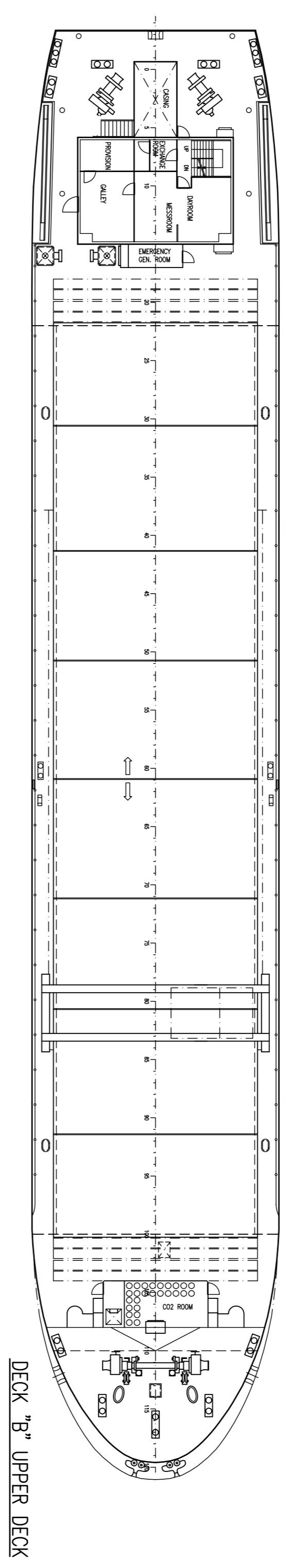
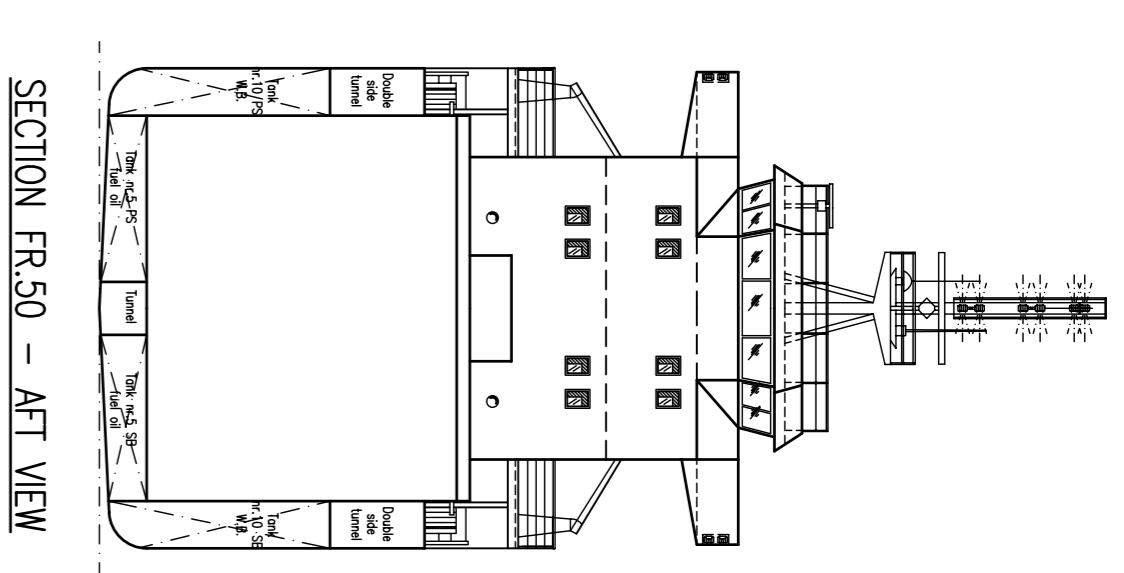
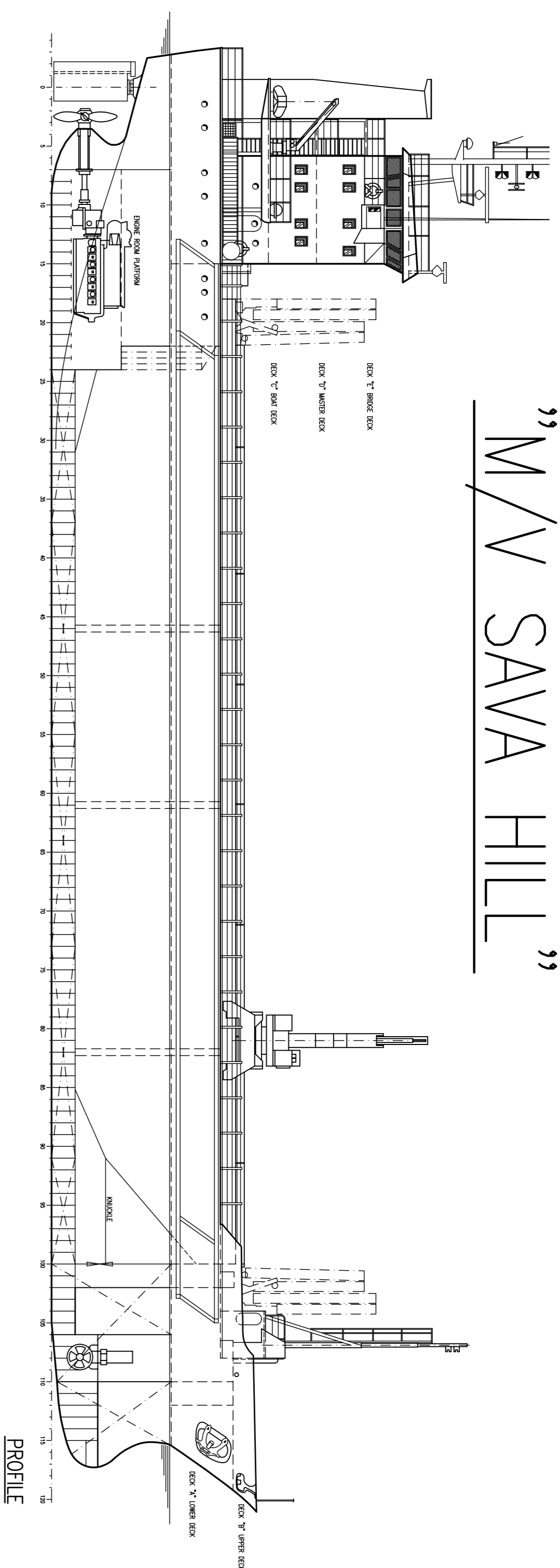

MAIN DIMENSION:

LENGTH OVER ALL:	74.65 m
LENGTH BETWEEN PERP.	69.10 m
BREADTH MLD.:	12.70 m
DEPTH TO UPPER DECK:	8.60 m
DESIGN DRAUGHT:	6.10 m
SCANTLING DRAUGHT:	6.10 m
DEADWEIGHT:	3110 t.
GROSS TONNAGE:	abt. 2026 g.t.

POS. / ITEM	QTY.	MATERIAL	DRIVING NO.	REMARK
GENERAL ARRANGEMENT				
M/V SAVA HILL				
Scale:	1:200	Drawn:	GUR	17.03.04
Format:	A1	Created:		
Project no.:	S1177/04-03			
SFT-no.:				
Drawing no.:	B783			
Rev.	B			
Sheet	1 of 1			

REV.	DESCRIPTION	DATE/SIGN
B	CORR. ACC. TO OWNERS COMMENTS	30.04.04/DY
A	CORR. ACC. TO OWNERS COMMENTS	19.01.04/DY

SAVICON AS
 Design and Marine Engineers
 N-9162 LAKSEVÅG
 TEL.: 55 34 99 20
 FAX.: 55 34 99 21
 E-mail: savicon@online.no